



GRIZZLE™ ULTIMATE 48A EV CHARGER INSTALLATION MANUAL





GRIZZL-E ULTIMATE 48 INSTALLATION MANUAL

This manual is for the installation of the Grizzl-E Ultimate 48A Level 2 EVSE. This manual includes information on the safety, installation, moving, and storage of the EVSE. This document provides instructions for the listed model numbers and should not be used for any other product.

The user assumes full responsibility for ensuring the safe and correct use of this product. Failure to do so may result in injury or damage. Read all the instructions carefully and exercise caution when using this product.

Manual Revision: 1.3
October, 08, 2024

Model Numbers:

- GRU-077-W-HW-25I48-A-GB
- GRU-077-W-HW-25I48-A-GW
- GRU-077-W-HW-25T48-A-GB
- GRU-077-W-HW-25T48-A-GW



TABLE OF CONTENTS

1. IMPORTANT SAFETY INSTRUCTIONS	1
1.1 INSTRUCTIONS PERTAINING TO A RISK OF FIRE OR ELECTRIC SHOCK	1
1.2 USER MAINTENANCE INSTRUCTIONS.....	2
1.3 MOVING, TRANSPORTING, AND STORAGE INSTRUCTIONS	2
2. PRODUCT SPECIFICATIONS	3
3. INTRODUCTION & UNPACKING	4
3.1 YOUR CHARGER	4
3.2 PACKAGE CONTENTS	5
4. INSTALLATION PLANNING AND SERVICE WIRING:	6
4.1 ELECTRICAL SOURCE REQUIREMENTS	6
4.2 GROUNDING INSTRUCTIONS	7
4.3 GFCI	7
5. ADJUSTABLE MAXIMUM CURRENT OUTPUT	8
5.1 ADJUST MAXIMUM CURRENT OUTPUT	8
6. INSTALLATION	11
6.1 INSTALL THE CHARGING STATION	11
7. HARDWIRE CONNECTION	14
7.1 PREPARE WIRING	14
7.2 HARDWIRE CHARGER.....	15
7.3 INSTALLATION WARNINGS.....	17
8. EASYEVPLUG HOLSTER	18
WARRANTY	19

1. IMPORTANT SAFETY INSTRUCTIONS

This document contains instructions and warnings that must be followed when installing the Grizzl-E Ultimate 48A Level 2 Electric Vehicle Supply Equipment (EVSE). Before installing the EVSE, read this document including any WARNING and CAUTION symbols.

The Symbols Used Have the Following Meanings



WARNING: risk of personal injury



WARNING: risk of fire



WARNING: risk of electric shock

















CAUTION: risk of damage to equipment

- This document provides instructions for the charging station and should not be used for any other product. Before installation of this product, review this manual carefully and consult with a licensed contractor, licensed electrician, or trained installation expert to ensure compliance with local building codes and safety standards.
- Consult a licensed electrician to ensure that this product can be safely installed.
- Ensure that the materials used, and the installation procedures, follow local building codes and safety standards.
- The information provided in this manual in no way exempts the user of responsibility to follow all applicable codes or safety standards.

1.1 INSTRUCTIONS PERTAINING TO A RISK OF FIRE OR ELECTRIC SHOCK

Basic precautions should always be followed when using electrical products, including the following:

-   Read all the instructions before using this product.
-   Children should not use this device.
-   Do not put fingers into the EV connector.
-   Do not touch live electrical parts.
-   Do not use this product if the flexible power cord or EV cable is ragged, has broken insulation, or any other signs of damage.
-   Do not use this product if the enclosure or the EV connector is broken, cracked, open, or shows any other indication of damage.
-   To avoid a risk of fire or electric shock, do not use this device with an extension cord or electrical adapter.

SAVE THESE INSTRUCTIONS

1.2 USER MAINTENANCE INSTRUCTIONS

The Grizzl-E Ultimate 48A Level 2 EVSE does not require routine maintenance. Check before each charging session to ensure that cables and enclosure remain in good working order and no damage exists.

The exterior of the charging station is designed to be waterproof and dustproof (UL Type 4 Indoor/Outdoor Rating). However, periodic cleaning may be required.

To ensure proper maintenance of the charging station, follow these guidelines:

- Only use an automotive-grade soft cleaning cloth with soap and water to clean. Do not use cleaning solvents.
- Submerging the unit under water is not recommended.
- Ensure the output cable is stored on the holster after use to avoid damage.

Do not attempt to open, disassemble, repair, tamper with, or modify any components of the products. Contact Technical Support for any repairs.

1.3 MOVING, TRANSPORTING, AND STORAGE INSTRUCTIONS

- When moving or lifting the unit, always grasp and carry by the charging station body. Never attempt to carry the unit by any of the electrical cables.
- Store the unit in a dry location, away from standing water.
- Store the unit at a temperature between -30C (-22F) to 70C (158F).



WARNING: This equipment is intended only for charging vehicles that do not require ventilation during charging. Please refer to your vehicle's owner's manual to determine ventilation requirements.



WARNING: Disconnect the power supply to the charging station before installing or adjusting the charging station. Failure to do so may result in physical injury or damage to the power supply system and the charging station.

2. PRODUCT SPECIFICATIONS

Description	Specifications
EVSE Level	AC Level 2
Max Output Rating	48A; 11.5 kW Maximum Output For use with a 60A Circuit Rating
Adjustable Output Ratings	40A; 9.60 kW Maximum Output – For use with 50A Circuit Rating 32A; 7.68 kW Maximum Output – For use with 40A Circuit Rating 24A; 5.76 kW Maximum Output – For use with 30A Circuit Rating 16A; 3.84 kW Maximum Output – For use with 20A Circuit Rating
Charging Connector	SAE J1772
Charge Cable Length	25 ft. (7.6m)
Electrical Circuit / Input Power Requirements	Dedicated 208VAC Single Phase or 240VAC Split Phase, 50/60 Hz.; Branch Breaker: Double pole; Circuit Conductors: Line 1, Line 2, Earth/Ground
Input Power Connection	Hardwire Connection
Installation Rating	UL Type 4 Indoor/Outdoor Rating Indoor/Outdoor Rated
Operational Ratings	Temperature: -22°F to 122°F (-30°C to 50°C); Humidity: 95% RH non-condensing
Overall Dimensions	EVSE: 10.25 x 6.25 x 3.75 inches (26.0 x 16.0 x 9.3 cm)
Overall Weight	21lbs (9.5kg)
Connectivity	2.4Ghz Wi-Fi network
Display & Indicators	LED Charge Status Indicators (Power/Ready, Charging, Fault)
Certification	UL Certified. E510712

3. INTRODUCTION & UNPACKING

3.1 YOUR CHARGER

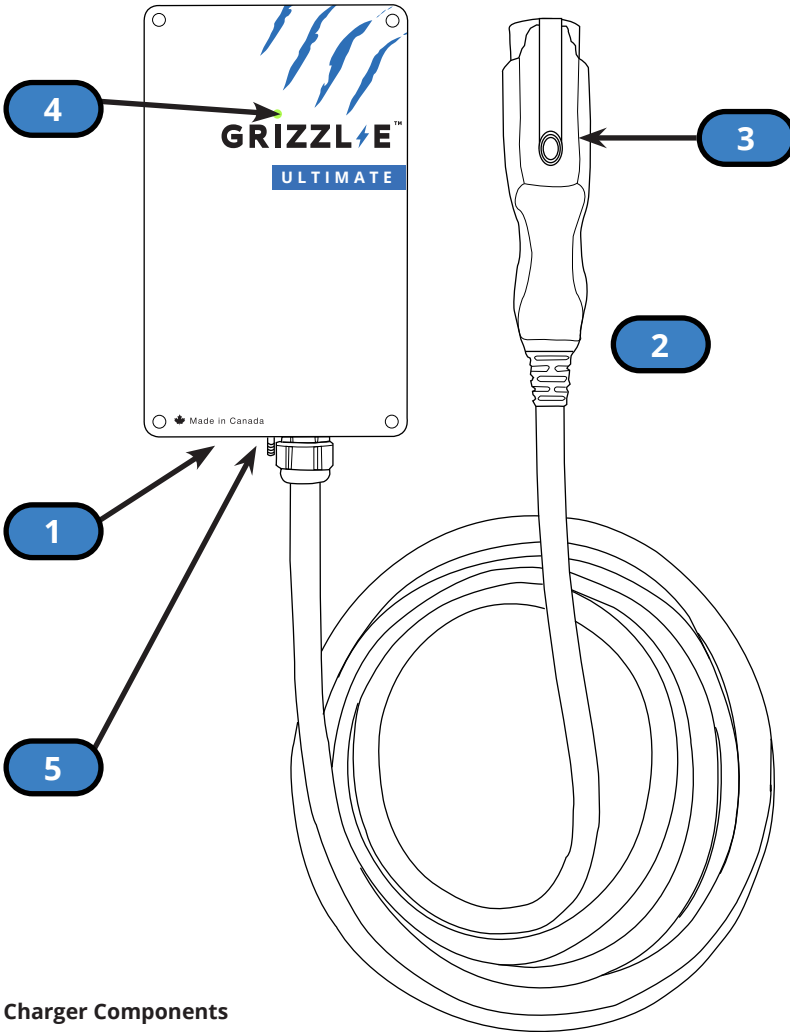

Charger Components

1. Input Hardwire Connection
2. Output Cable J1772 Connector
3. Latch Release Button
4. Indicator Light
5. External Antenna

3.2 PACKAGE CONTENTS

Mounting Kit

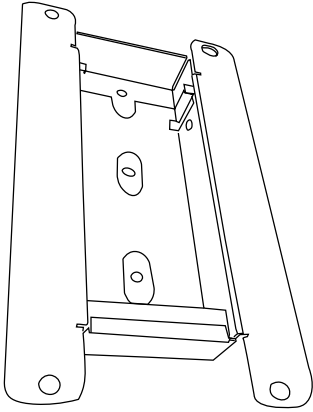

Mounting Bracket (x1)

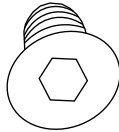

Front Plate
Screw (x4)

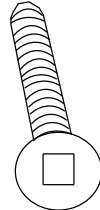

Back Plate
Screws (x2)

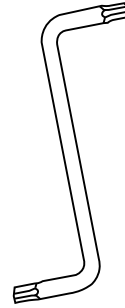

Hex Key Tool (x1)

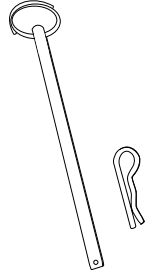

Security Pin(x1)

Hardwire Kit

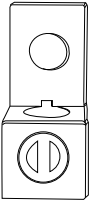

Terminal Lugs (x3)

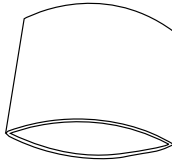

Shrink Wrap (x3)



Terminal Screws

Charging Holster

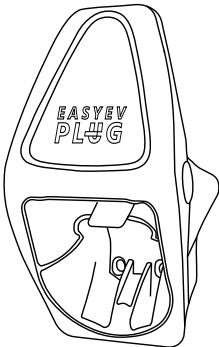

Holster (x1)

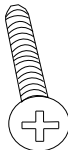

Phillips-head
Screws (x4)

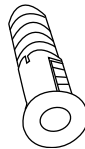

Anchor (x4)

4. INSTALLATION PLANNING AND SERVICE WIRING:



WARNING: Disconnect the power supply to the charging station before installing or adjusting the charging station. Failure to do so may result in physical injury or damage to the power supply system and the charging station.



WARNING: To reduce the risk of fire, connect only to a circuit provided with 20-60 amperes maximum branch circuit overcurrent protection requirements in accordance with the National Electrical Code ANSI/NFPA 7- and the Canadian Electrical Safety Code, Part 1, C22.1. If you are unsure if your circuit meets these requirements consult a licensed contractor, licensed electrician, or trained installation expert.

4.1 ELECTRICAL SOURCE REQUIREMENTS

- Prior to mounting, locate an available electrical source that can support the following Input Requirements for the Charging Station Per local Electrical Safety Code requirements:
 - » 48A Maximum Output Setting: DEDICATED CIRCUIT rated for 60A; 208VAC Single Phase or 240VAC Split Phase, 50-60 Hz,
 - » 40A Maximum Output Setting: DEDICATED CIRCUIT rated for 50A; 208VAC Single Phase or 240VAC Split Phase, 50-60 Hz,
 - » 32A Maximum Output Setting: DEDICATED CIRCUIT rated for 40A; 208VAC Single Phase or 240VAC Split Phase, 50-60 Hz,
 - » 24A Maximum Output Setting: DEDICATED CIRCUIT rated for 30A; 208VAC Single Phase or 240VAC Split Phase, 50-60 Hz,
 - » 16A Maximum Output Setting: DEDICATED CIRCUIT rated for 20A; 208VAC Single Phase or 240VAC Split Phase, 50-60 Hz,
- A Double Pole Circuit Breaker of the circuit rating must be used.
- The Charging Station must be hardwired to the circuit panel. Do not use this device with an electrical plug, extension cord, or electrical adapter.

4.2 GROUNDING INSTRUCTIONS

This product must be grounded. If it should malfunction or break down, grounding provides a path of least resistance for electric current to reduce the risk of electric shock. This product is equipped with a cord having an equipment grounding conductor.

An insulated grounding conductor that is green with or without one or more yellow stripes, shall be installed as part of the branch circuit that supplies the device or system.

The grounding conductor shall be grounded to earth at the service equipment or, when supplied by a separately derived system, at the supply transformer.



WARNING: Improper connection of the equipment-grounding conductor is able to result in a risk of electric shock. Check with a qualified electrician or serviceman if you are in doubt as to whether the product is properly grounded.

4.3 GFCI

The Charger is equipped with GFCI. Additional downstream GFCI is not required.

5. ADJUSTABLE MAXIMUM CURRENT OUTPUT

The Grizzl-E Ultimate EVSE features the ability to adjust the maximum current output to support 60A, 50A, 40A, 30A, or 20A Dedicated Circuit ratings as follows:

Circuit Rating	Maximum Charging Station Output
60A	48A (11.56 kW)
50A	40A (9.6 kW)
40A	32A (7.68 kW)
30A	24A (5.76 kW)
20A	16A (3.84 kW)

Requirements govern that only 80% of the circuit-rated load may be utilized.

5.1 ADJUST MAXIMUM CURRENT OUTPUT

1. Remove the front cover by removing the 4 screws at each corner of the charging station. Use the Hex Key Tool to remove the front cover. Do not use power tools.



CAUTION: Do not use power tools to remove screws, as this may strip the screws. Use the provided Hex Key Tool.



CAUTION: The LED pipe is attached to the front cover. Place the cover facing down on a flat surface to avoid damage to the LED pipe.

2. Place the front cover to the side. Locate the DIP switch on the charging station circuit board. The DIP switch is a 4-position switch on the top circuit board, located on the right side of the charger.

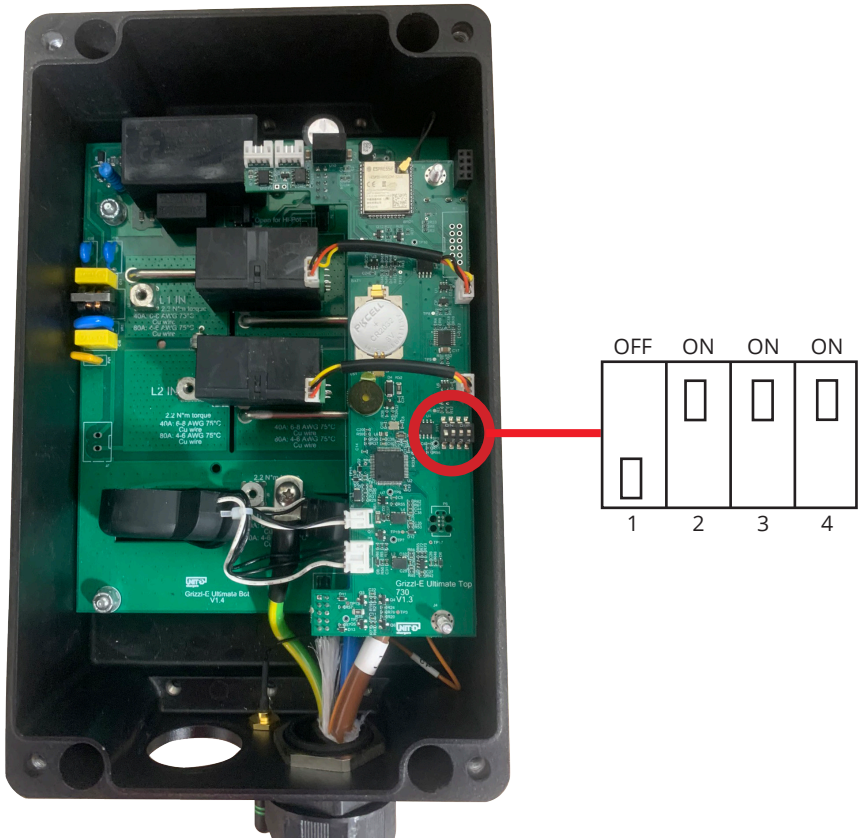

WARNING: Do not touch live electrical parts. Disconnect the power supply to the charging station before adjusting the DIP Switches. Failure to do so may result in physical injury or damage to the charging station.

3. Adjust the Maximum Current Output to either 48A, 40A, 32A, 24A or 16A, using the following combination of DIP switch settings:

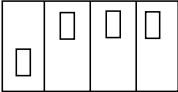
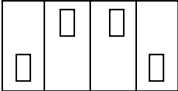
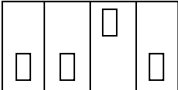
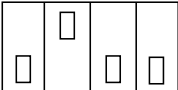
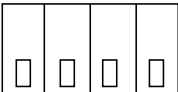
Maximum Current	Switch 1	Switch 2	Switch 3	Switch 4	Diagram
48A Maximum Current Output	OFF	ON	ON	ON	
40A Maximum Current Output	OFF	ON	ON	OFF	
32A Maximum Current Output	OFF	OFF	ON	OFF	
24A Maximum Current Output	OFF	ON	OFF	OFF	
16A Maximum Current Output	OFF	OFF	OFF	OFF	

4. Once the DIP Switch Setting is adjusted, reassemble the charging station. Reinstall the top cover to the charging station using the following torque force to secure the (4) socket cap screw:

Screw	Torque
M4	1.6 Nm 14 lbf-in

6. INSTALLATION

6.1 INSTALL THE CHARGING STATION

Prior to mounting, determine the location of an acceptable mounting support. All charging station products must be anchored into a mounting support such as a 2" x 4" stud or a solid concrete wall. DO NOT mount this unit directly to a stucco/drywall.

1. Separate the front and back piece of the mounting bracket by pushing down on the notch.

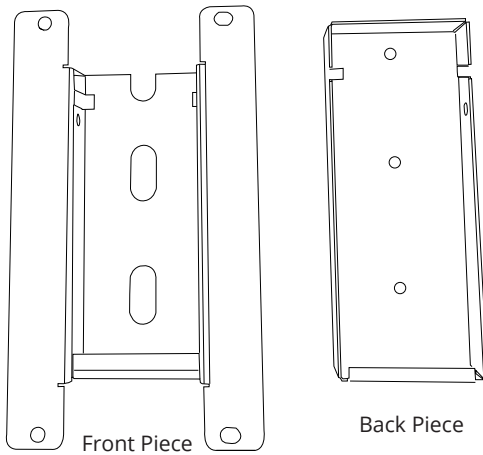

2. Attach the front piece of the mounting bracket to the back of the charging station using the Socket-cap screws and Hex Key Tool. Ensure the top of the mounting bracket is matched with the top of the charging station.

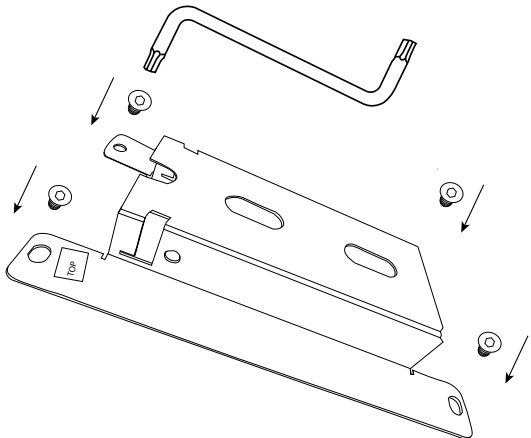

3. Secure the back piece of the mounting bracket to the wall or other suitable structure using the Robertson-head screws.

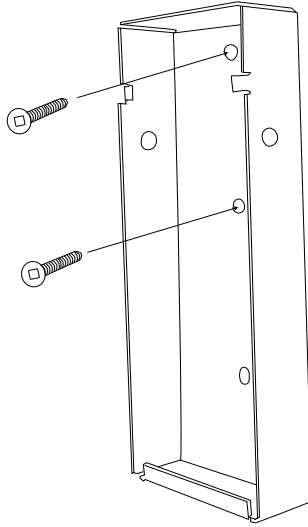

The back piece of the mounting bracket has 3 holes to support attachment to various surfaces.

Use the top two holes to attach the mounting bracket to a wall stud.

Mounting Screw Recommendations:

- For finished walls supported by wood studs, use #14 or M6 tapping screws. (Included).
- For masonry walls, use M6 mechanical screws. (Commercially available)

This device shall be mounted at a sufficient height from grade such that the height of the storage means for the coupling device is located between 0.45m (18") and 1.2 m (48") from grade.

4. Mount the charger on the wall by securing the front piece of the mounting bracket to the back piece of the mounting bracket.

The EVSE shall be installed with the power supply cord managed so that it cannot contact the floor once the EVSE is installed.

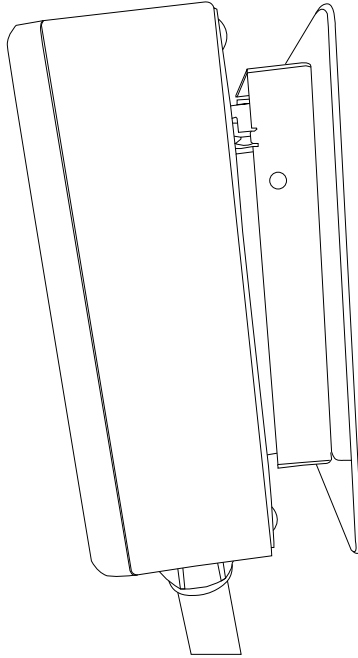

5. Secure the charger in place by inserting either the security pin or the outdoor security lock into the mounting bracket.

7. HARDWIRE CONNECTION



WARNING: Wiring connection must be done by a licensed contractor, licensed electrician, or trained installation expert. Follow all applicable electrical codes and safety standards. Ensure all parts and tools meet regulations. Failure to wire station correctly may lead to risk of electrocution, personal injury, or fire.

7.1 PREPARE WIRING

1. Choose appropriate wire gauge based on maximum output current settings. Use heat shrink tube to cover the non-insulated portion of the terminal.

Maximum Current Output (As set by DIP Switches)	Wire Gauge L1 L2	Wire Gauge G
48A	4-6 AWG	4-8 AWG
40A	6-8 AWG	6-10 AWG
32-16A	8 AWG	8-10 AWG
24A	8 AWG	8-10 AWG
16A	8 AWG	8-10 AWG

See [Chapter 5. Adjustable Maximum Current Output](#) on page 8 for more information on maximum output current.

Follow all applicable electrical safety codes and standards. Use Red wire for L1, Black wire for L2, Green wire for G.

2. Choose an appropriate conduit in accordance with all applicable electrical safety codes and standards. Diameter of the enclosure opening is 1.26" (32mm).



7.2 HARDWARE CHARGER

1. Remove the front cover of the charging station by removing the 4 screws at each corner. Use the Hex Key Tool to remove the front cover. Do not use power tools.
2. Connect conduit to the bottom of the enclosure.
3. Use the Terminal Screws to connect the Terminal Lugs to the Terminal Connectors. Connect Terminal Lugs to L1, L2, and G. Use Phillips Head (PH3) screwdriver to connect terminal screws. Torque Terminal Lugs to 2.2 Nm (20 lbf-in).

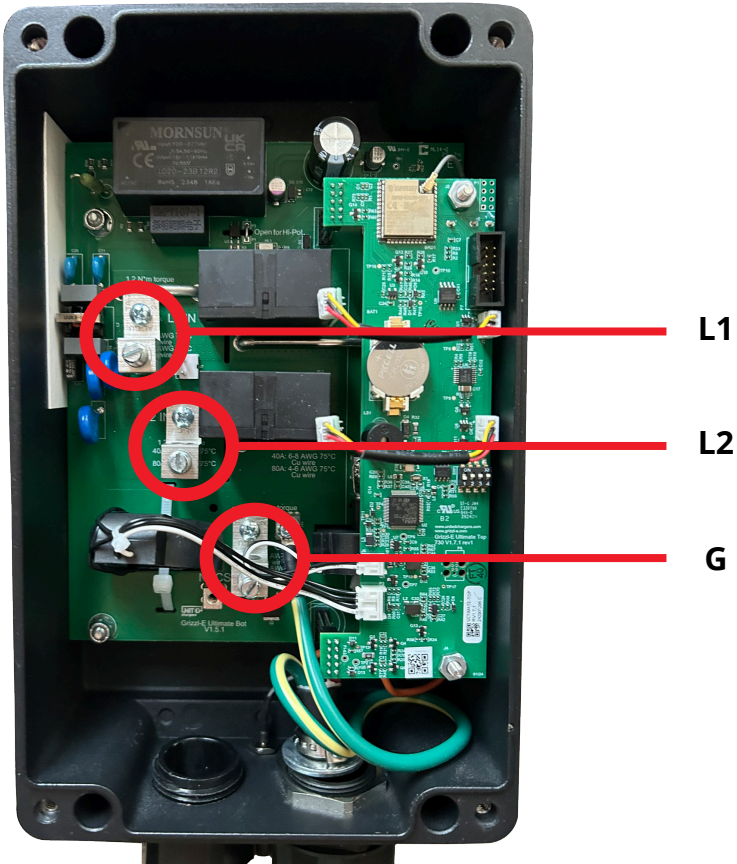

LUG TERMINAL SPECIFICATION

Terminal Part Number	Terminal Material	Terminal Type
McMASTER-CARR 6920K21	Tin-Plated Aluminum	Lug Screw-Clamp Terminal

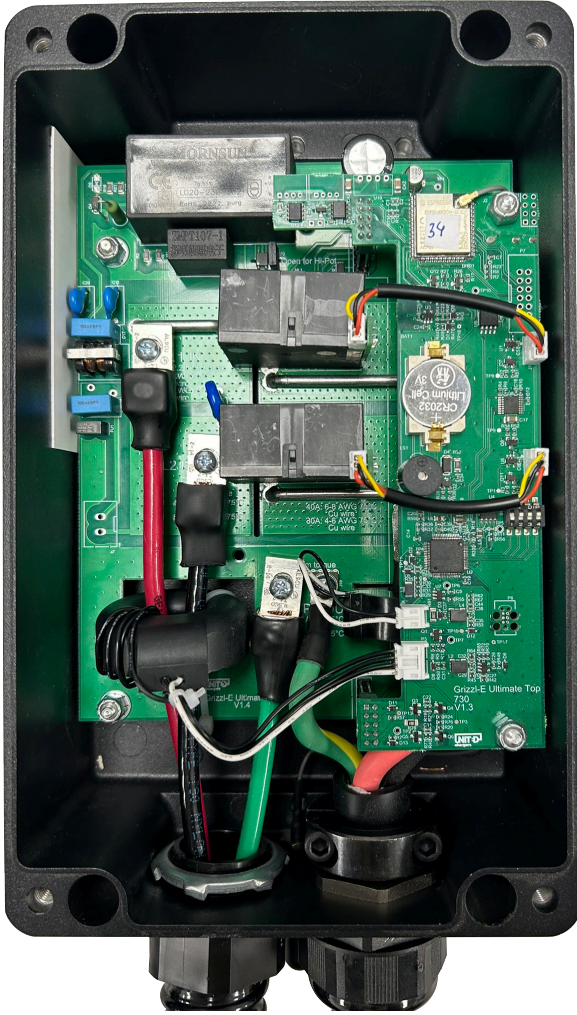

4. Feed the input wires (L1, L2, G) through the conduit into the charger.
5. Feed L1 and L2 wire through the transformer.
6. Place heat shrink tube over the terminal lugs.
7. Insert G, L1, and L2 wires to the corresponding Terminal Lug.
8. Secure the wires to the Terminal Lug using the screw. Torque Terminal screw to 2.2 Nm (20 lbf-in).
9. Use a heat gun to shrink the tubing around wire and terminal lug.
10. Once the input wiring and conduit are connected, reassemble the charging station. Reinstall the charging station cover. Torque Cover to 1.6 Nm (14 lbf-in).

WIRE SPECIFICATION

Terminal	Conductor	Rating
L1, L2, G	4-8 AWG (G 4-10 AWG)	75C, Copper Wire

7.3 INSTALLATION WARNINGS

The licensed contractor, licensed electrician, or trained installation expert should exercise caution when performing the installation.

 Do not unmount or disconnect the top PCB from the bottom PCB

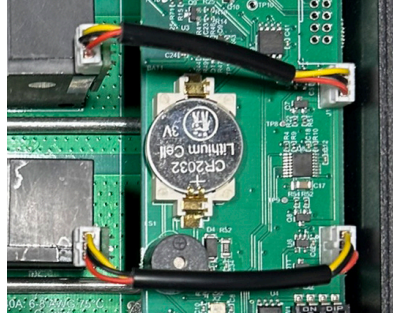

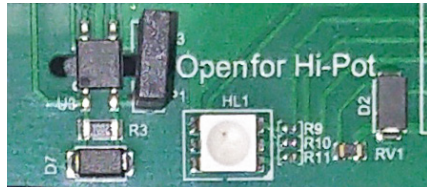

 Do not touch or remove the white connectors from their housing

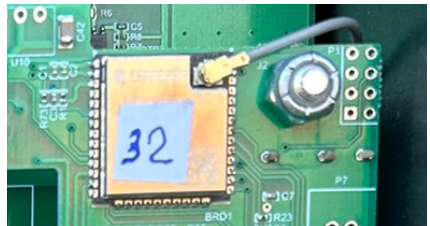

 Do not touch or manipulate the shunt

 Do not touch or remove the grey wire connected to the Wi-Fi module



 Do not touch or manipulate the 3.3V power supply whether its orientation is on the top or bottom of the PCB.

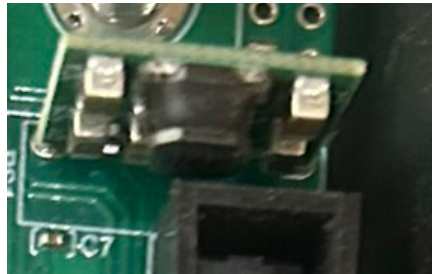

8. EASYEVPLUG HOLSTER

The EasyEvPlug Holster is used to protect the charging plug and manage the cable when the EVSE is not in use.

The Plug Holster can be installed at any location near the charging station.

To install the EasyEvPlug Holster:

1. Hold back of holster against the mounting surface. Fasten Phillips head screws through back holes. Use anchors if attaching directly to drywall.

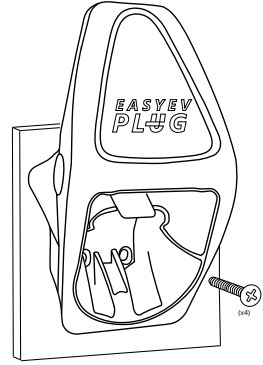

2. Insert charging connector into holster.

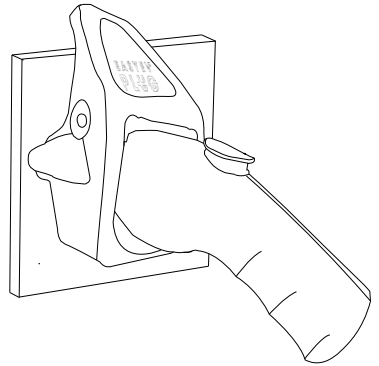

3. Wrap cable on top of the holster.

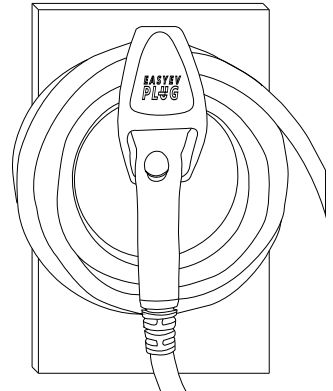

Note: Remove rubber cap from charging gun before inserting into holster. Failure to do so may result in damage to the cap or holster.



WARRANTY

Grizzl-E Ultimate Level 2 EVSE comes with either a 3-year, or 5-year manufacturer's warranty. This warranty is extended by United Chargers Inc.™ to the original purchaser of the EV Charging Station. United Chargers warrants that this product is free from defects in materials years and free from defects in workmanship for the period specified in the warranty from the date of purchase. If during the Warranty Period, under normal operating conditions, the charging station becomes defective, United Chargers will, upon written notice of the defect that occurred during the Warranty Period, provide technical support until the issue is resolved.

This warranty will not apply if the product has been misused, abused, or altered. The warranty does not cover cosmetic damage such as scratches, dents, or normal aging. The warranty does not cover damage as a result of an extreme power surge, extreme electromagnetic field, or any acts of nature. This warranty will not apply if the product is used with any third-party extension cords or electrical adapters. The warranty for the cable does not include normal tear and wear. This warranty does not cover plugs exposed to snow or water for an extended time. The warranty for the cable does not include cables that have been run over, pulled, or otherwise damaged by the vehicle.

A licensed contractor, licensed electrician, or trained installation expert must perform the installation and hardwire procedure, or the warranty will be void. Proof that installation and hardwire services were performed by a qualified professional (i.e., electrician bill, Work order, Invoice, etc.) is required. The qualified installer is responsible for ensuring the charging station front cover is reassembled according to specifications and responsible for any damages or water leakage to the enclosure

The warranty claimant must produce the original purchase invoice, including the date of purchase. United Chargers assumes no liability for any dismantling, removal, installation, re-installation, or labor costs or any consequential damages associated with this warranty. The cumulative liability of United Chargers for warranty claims will not exceed the original price of the charging station. United Chargers shall make the final decision, in fairness to all concerned, as to the legitimacy of any such claim on this warranty.

View the full terms and conditions: <https://grizzl-e.com/returns/>

SAVE THESE INSTRUCTIONS

The most up to date User Manual is available online:

<https://grizzl-e.com/user-manuals/>

Visit our Technical Support page:

<https://autochargers.zendesk.com/hc/en-ca>

View the full terms and conditions:

<https://grizzl-e.com/returns/>

Phone: +1-833-971-8118

E-mail: info@unitedchargers.com

Website: <https://grizzl-e.com/>

United Chargers Inc.
25 Pollard St, Richmond Hill,
ON, Canada, L4B 1A8



